

Motors & Actuators

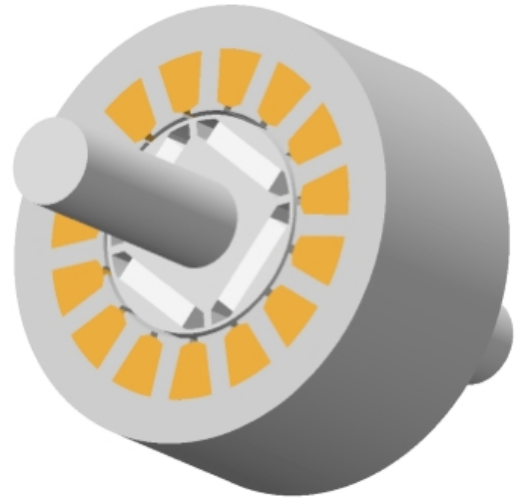

Design & supply of magnets and magnetic assemblies for motors, actuators, machines and drives application

Eclipse Magnetics designs, produces and supplies magnets and magnetic assembly solutions for the varied application requirements for a very diverse range of permanent magnet motor and actuator designs.

PM Electrical Machine Solutions

Design, improve, optimise, supply, support

Eclipse Magnetics understands the needs of electrical machine, motor, drive and actuator customers to design commercially viable PM machine solutions that have any of reduced weight, higher power density, compact design, longer service life, reduced cost or higher efficiency. This even includes Rare Earth free design alternatives. We can help with carbon footprint reduction, Electricity Demand Reduction (EDR) and lowering CO2 emissions.

Whether the application is designing out rare earth magnets for ferrite replacements, increasing power density, miniaturisation, efficiency improvement, enhanced flux concentration at the poles, using external or internal rotors, temperature compensation, powdered iron use, eddy current reduction, torque ripple reduction, or energy demand reduction, Eclipse Magnetics will help you get your solution. We can even magnetically balance the rotor to even out back emf in each phase to simplify the power electronics.

We like to use mutual NDA. We can assist you to design for back emf, torque, field strengths, position sensing, weight reduction, miniaturisation, higher efficiency, cost reduction and even rare earth replacement.

We have Dr Ewan Goodier, an Electronic & Electrical Engineer with a PhD in the field of motor designs that use magnets, to assist with your application design and technical support.

Our China Joint Venture also allows us to supply our solutions with PPAP and C of C.

We even offer methods to allow for better recyclability to help meet WEEE requirements.

With an unrivalled expertise in designing value adding magnetic solutions Eclipse Magnetics is a trusted partner for reliable long-term contract manufacturing supply. This includes holding stock in UK for guaranteed fast call off supply.

Application examples include:-

- Permanent Magnet Motors
- Direct Drives
- Hybrid Drives
- Internal Rotor Magnets
- External Rotor Magnets
- Stator Magnets
- Linear Actuators
- Servo Motors

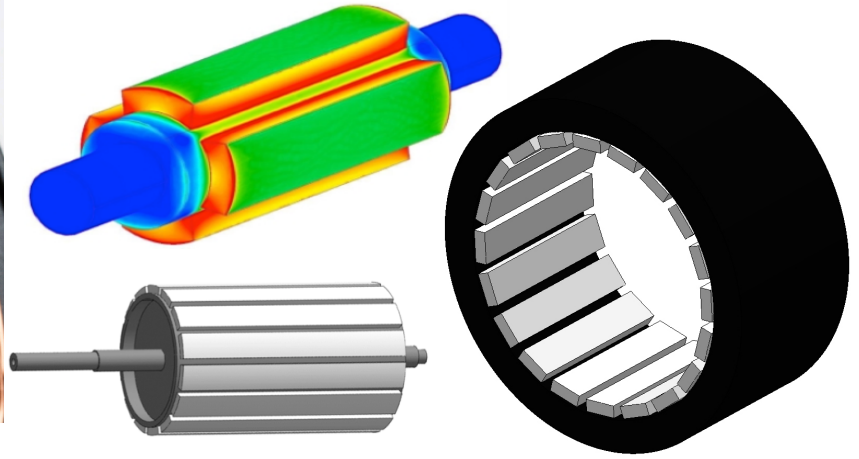
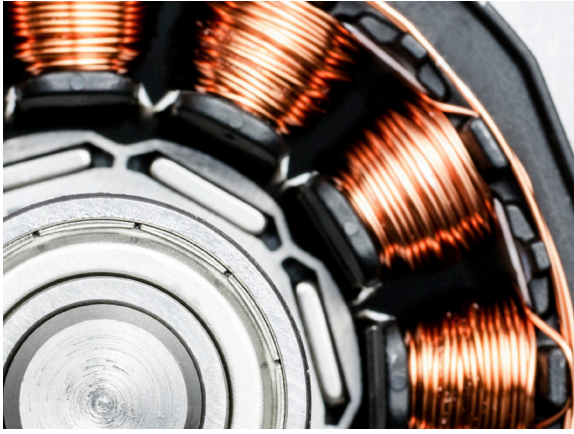

BREADLOAFS

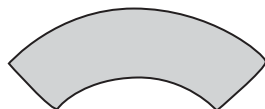

CONCENTRIC RADIUS ARCS

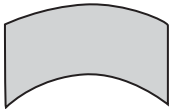

DISSIMILAR RADIUS ARCS



FLAT SURFACE ARCS

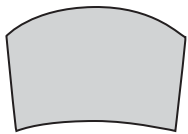

VARIABLE RADIUS & SIDES



RECTANGULAR BLOCKS

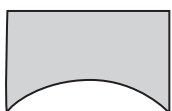

CURVED BLOCKS



TRAPEZOIDS

Application examples:

- Direct Drives
- Hybrid Drives
- Variable Reluctance Machine
- Ironless Rotor Motors
- Synchronous Motors
- DC Motors
- Axial Rotor Motors
- Internal Rotor Motors
- External Rotor Motors
- Interior PM Synchronous Motor
- Surface PM Synchronous Motor
- Permanent Magnet (PM) Motors
- Brushed DC Motor
- PM DC Motor
- Brushless DC Motor
- PM Synchronous Motor
- Stepper Motor
- Axial Flux PM Machine
- Transverse Flux Machine
- PM Flux Switching Motor
- Hybrid Stepper Motor
- Pancake Motor

Permanent Magnet Machine Assemblies:-

We can supply PM motor assemblies and sub-assemblies to customer design drawings. We also magnetically balance for multi-phase!

Please contact us to arrange a visit, request a quotation or to get technical support and design help.

www.eclipsemagnetics.com
www.magnets2buy.com

Eclipse Magnetics Ltd, Atlas Way, Sheffield, S4 7QQ, England

T +44 (0)114 225 0600 F +44 (0)114 225 0610 E info@eclipsemagnetics.com W www.eclipsemagnetics.com

While every effort has been made to ensure the accuracy of the information in this publication please note that specifications may change without notice.



FM31278



A world leader in magnetic technology



A Spear & Jackson Company